

Specifications 4590
(Replacing Specifications 3857 and
part of Specifications 4160)

STATIONS

No. 50 COIN COLLECTOR

INSTALLATION

Contents	Page
DETAILED TABLE OF CONTENTS.....	2
APPARATUS AND MATERIALS.....	5
GENERAL	9
SELECTION OF APPARATUS.....	9
ENTERING BUILDINGS	11
LOCATING COIN COLLECTORS	11
MOUNTING COIN COLLECTORS	14
WIRING	25
No. 50 COIN COLLECTORS OPERATING ON POSTPAYMENT BASIS	31
CONNECTIONS	33
CONVERSIONS	41
TESTS AND ADJUSTMENTS	46

(Copyright, 1927, by American Telephone and Telegraph Company)

Printed in U. S. A.

DETAILED TABLE OF CONTENTS

	SEC.	PAGE.
APPARATUS AND MATERIALS		
Names of Standard Apparatus and Materials	1	5
GENERAL		
Scope	2	9
SELECTION OF APPARATUS		
Coin Collectors in Manual Districts.....	3	9
Coin Collectors in Machine Switching Districts	4	10
Transmitters and Receivers.....	5	10
Use of Waterproof Cords.....	6	10
Instruction Cards	7	10
Keys and Switches	8	11
Subscriber's Sets	9	11
ENTERING BUILDINGS		
At Stations with Protectors.....	10	11
At Stations without Protectors.....	11	11
LOCATING COIN COLLECTORS		
According to Service Order	12	11
According to General Rules	13	12
Height of Coin Collectors.....	14	13
MOUNTING COIN COLLECTORS		
General Rules	15	14
Use of Backboards	16	14
Number and Location of Fasteners.....	17	14
Mounting Coin Collectors without Backboards	18	15
Mounting Coin Collectors on Horizontal Surfaces	19	17
Mounting Coin Collectors on Walls with Backboards	20	18
Fastening No. 144 Backboards to Masonry Walls	21	19
Locating Studding and Furring on Wood or Metal Lath Walls.....	22	20
Fastening No. 144 Backboards to Wood Lath and Metal Lath Walls.....	23	21

	SEC.	PAGE.
Locating Studding or Furring on Metal Sheathed Walls	24	22
Fastening No. 144 Backboards to Metal Sheathed Walls	25	23
Fastening Coin Collector and Subscriber's Set to Backboard	26	25
WIRING		
Selection of Wire. Prepayment Operation...	27	25
Installing Wire	28	27
Multiple Installations not in Booths.....	29	27
Installations in Booths.....	30	27
Cable for Booth Wiring.....	31	29
Signaling Ground Connection.....	32	30
Terminating Wires at Coin Collector.....	33	31
#50 COIN COLLECTOR OPERATING ON POST PAYMENT BASIS		
Wiring	34	31
Special Arrangement of #50-G Coin Collector for Post Payment Operation.....	35	32
CONNECTIONS		
Use of Side Tone Reduction Circuit.....	36	33
Diagrams of Connections.....	37	34
Negative Side of Central Office Battery Grounded	38	38
Modified Coin Collector Circuits for Local Battery Talking	39	38
CONVERSIONS		
Converting #50-A or F Coin Collectors for Machine Switching Operation.....	40	41
Converting #50-G or H Coin Collectors from Manual to Machine Switching Operation	41	41
Converting #50-K or L Coin Collectors from Post Payment to Manual Prepayment Operation	42	42
Installing #2 Type Dial.....	43	43
Installing #1-B Card Holder.....	44	44
Installing #35-A Dial Mounting.....	45	45

DETAILED TABLE OF CONTENTS

TESTS AND ADJUSTMENTS

	SEC.	PAGE.
Switchhook Contacts, Transmitters, Receivers		
and Ringers	46	46
Signal Gongs	47	46
Coin Trigger	48	46
Ground Spring Contacts.....	49	46
Calling Central Office.....	50	46
Testing Operation of Coin Relay.....	51	47
Testing Dials	52	47
Identifying Machine Switching Lines.....	53	47
Testing Coin Collector for Grounds.....	54	47

STATIONS

No. 50 COIN COLLECTOR

INSTALLATION

APPARATUS AND MATERIALS

1. Names of standard apparatus and materials required for use by these specifications are given below:

- Anchors:** 1/4 IN. MACHINE SCREW ANCHOR.
- Apparatus Blanks:** #50-C APPARATUS BLANK.
Used to cover dial hole on coin collectors (arranged to mount dials) when used at manual stations. Rectangular metal plate. Includes instruction card frame and glass.
- Backboards** #139-A BACKBOARD.
Metal backboard for use with #50 Coin Collector when mounted on a horizontal surface.
- #144-B BACKBOARD.
Hardwood backboard for use with Coin Collectors when mounted on vertical surfaces, other than wood. **Equiv. #144-A**
- Blocks:** #12-C CONNECTING BLOCK.
#30-B CONNECTING BLOCK.
#30-C CONNECTING BLOCK.
#30-D CONNECTING BLOCK.
- Bolts:** 3/16 IN. X 1-1/4 IN. CARRIAGE BOLTS or approved equivalent.
1/4 IN. X (Length) CARRIAGE BOLTS.
- Brace:** () IN. X () IN. IRON CORNER BRACE.
- Cable:** U-6 CABLE.
U-11 CABLE.
U-16 CABLE.
or approved equivalent.

APPARATUS AND MATERIALS

- Card Holder:** **#1-B CARD HOLDER.**
For mounting the instruction card on #50 Coin Collectors operating on a machine switching basis. Includes instruction card frame and glass.
- Clamp:** **BLACKBURN A-1-S GROUND CLAMP.**
Code Number Plate: **CODE NUMBER PLATE. P-212118**
For use when converting #50K or L Coin Collector to prepayment operations.
- Coin Collectors:** **#50-G COIN COLLECTOR.**
Multi-coin prepayment coin collector for use at either machine switching or manual stations. Equivalent for manual common battery stations only: #50-A Coin Collector.
#50-H COIN COLLECTOR.
Same as #50-G except that the coin chute is arranged to accept both United States and Canadian quarters and dimes and is marked on the back with the word "Canadian." Used only in certain areas as covered in supplemental local instructions. Equivalent for manual common battery stations only: #50-F Coin Collector.
#50-K COIN COLLECTOR.
Multi-coin post payment coin collector for use at manual stations. May be converted to prepayment operation.
#50-L COIN COLLECTOR.
Same as #50-K except that coin chute is arranged to accept both United States and Canadian quarters and dimes and is marked on the back with the word "Canadian." Used only in certain areas as covered in supplemental local instructions.
- Coin Hopper:** **COIN HOPPER P-111873.**
For use in converting #50-K or L Coin Collectors to #50-G or H Coin Collectors.
- Coin Receptacles:** **#6001-A COIN RECEPTACLE.**
Self-locking type coin receptacle for use with #50 coin collectors. Not furnished as part of coin collector. Includes a #1-A Coin Receptacle, a #1-A Coin Receptacle Cover and a #1-A Coin Receptacle Rail.
#1-A COIN RECEPTACLE.
Part of #6001-A Coin Receptacle. Requires a #1-A Coin Receptacle Cover and a #1-A Coin Receptacle Rail to make a #6001-A Coin Receptacle.

#2-A COIN RECEPTACLE.

Open type coin receptacle for use with #50 coin collectors. Not furnished as part of coin collector.

Coin Receptacle Cover:**#1-A COIN RECEPTACLE COVER.**

Part of #6001-A Coin Receptacle. For use with #1-A Coin Receptacle in #50 Coin Collectors.

Coin Receptacle Rail:**#1-A COIN RECEPTACLE RAIL.**

Part of #6001-A Coin Receptacle. For use with #1-A Coin Receptacle and #1-A Coin Receptacle Cover.

Coin Relay:**COIN RELAY. P-145749**

For use in converting #50-K or L Coin Collectors to #50-G or H Coin Collectors.

Cords:**R2B CORD.**

Black waterproof receiver cord for #144 receivers on #50 Coin Collectors. **Equiv. #542**

T1A CORD—8 inch.

Transmitter cord for #50 Coin Collectors. Two required.

#595-B CORD.

Dial cord for #50 Coin Collectors.

Dials:**#2-AA DIAL.****#2-AB DIAL.****#2-AE DIAL.**

Used as covered in Specifications for Machine Switching Stations.

Dial Mounting:**#35-A DIAL MOUNTING.**

Used on #50 Coin Collectors as covered in Section 45.

Housing:**UPPER HOUSING FOR #50-G COIN COLLECTOR. P-166749**

Used when converting #50-A Coin Collectors for machine switching operation.

UPPER HOUSING FOR #50-H COIN COLLECTOR. P-167823

Used when converting #50-F Coin Collectors for machine switching operation.

Instruction Cards:**E-463.**

For use on #50 postpayment Coin Collectors at manual common battery stations.

Note: Instruction cards for coin collectors on prepayment operation, manual or machine switching, and on postpayment operation at magneto stations, shall be in accordance with supplemental local instructions.

APPARATUS AND MATERIALS

E-158.

Used when coin collector is temporarily out of service.

Label:**P-144701**

Circuit label for #50-G Coin Collector for use when converting #50-A or #50-K Coin Collectors.

Nut:**P-165486 HEXAGON NUT.**

For use in connection with installation of #1-B Card Holder.

Receiver:**#144 RECEIVER.**

For use on all #50 Coin Collectors.

Screws:

1-1/4 IN. #14 F.H. BRIGHT WOOD SCREW.

1-3/4 IN. #14 F.H. BRIGHT WOOD SCREW.

2-1/2 IN. #14 F.H. BRIGHT WOOD SCREW.

3 IN. #14 F.H. BRIGHT WOOD SCREW.

3-1/2 IN. #14 F.H. BRIGHT WOOD SCREW.

1-1/2 IN. x 1/4-20 F.H. BRIGHT MACHINE SCREW.

2 IN. x 1/4-20 F.H. BRIGHT MACHINE SCREW.

2-1/2 IN. x 1/4-20 F.H. BRIGHT MACHINE SCREW.

3 IN. x 1/4-20 F.H. BRIGHT MACHINE SCREW.

P-201135 R.H. SLOTLESS MACHINE SCREW.

Spring Assembly:**SPRING ASSEMBLY D-22990.**

For use in converting #50-A or F Coin Collectors to #50-G or H Coin Collectors.

Toggles:

1/8 IN. x 3-1/2 IN. B.H. TOGGLE or approved equivalent.

3/16 IN. x 4 IN. B.H. TOGGLE or approved equivalent.

Transmitters:

#323 TRANSMITTER.

#329 TRANSMITTER.

#337 TRANSMITTER.

For use on #50 Coin Collectors as required by the approved transmission zoning practice.

Washers:

P-165490 LOCK WASHER.

GENERAL

2. Scope. These specifications cover the installation of #50 coin collectors for both prepayment and postpayment operation. They also cover (1) the conversion at stations of #50 coin collectors from manual to machine switching operation and (2) the conversion at stations from postpayment to prepayment operation. Supplemental local instructions will govern whether the coin collectors are to be converted at the stations or are to be replaced by new coin collectors.

In prepayment operation the central office is obtained by depositing a coin; in postpayment operation the central office is obtained without depositing a coin.

In general, prepayment coin collectors are used only on individual lines. Postpayment coin collectors may be used on either individual or party lines.

Instructions applying to the #50-G, #50-K or #50-A coin collectors shall apply equally to the #50-H, #50-L or #50-F coin collectors respectively, where these coin collectors are used.

SELECTION OF APPARATUS

3. Coin Collectors in Manual Districts.

PREPAYMENT OPERATION.

Install either #50-G coin collectors equipped with #50-C apparatus blanks or #50-A coin collectors, except in districts which are to be cut over to machine switching. In such districts install #50-G coin collectors equipped with #50-C apparatus blanks at all new stations. When these coin collectors are to be changed to machine switching operation they shall be converted (see sections 40 and 41) or replaced in accordance with supplemental local instructions.

SELECTION OF APPARATUS

POSTPAYMENT OPERATION. COMMON BATTERY AND MAGNETO DISTRICTS.

Install #50-K coin collectors in manual districts except as covered by supplemental local instructions. When #50-K coin collectors are to be changed to prepayment operation they shall be converted in accordance with section 42.

In postpayment districts that are to be converted to prepayment in a short time #50-G coin collectors modified as shown in Section 35 may be installed instead of #50-K coin collectors if so specified by local supplemental instructions.

4. Coin Collectors in Machine Switching Districts.

MANUAL OPERATION.

Install #50-G coin collectors equipped with #50-C apparatus blanks at new stations which are to be operated on a manual basis unless otherwise specified by local supplementary instructions. When these coin collectors are to be changed to machine switching operation they shall be converted in accordance with section 41.

MACHINE SWITCHING OPERATION.

Install #50-G coin collectors equipped with dials and #1-B card holders.

5. Transmitters and Receivers. Coin collectors shall be equipped with #144 receivers and the type of transmitters required by the approved transmission zoning practice.

6. Use of waterproof cords. Use waterproof receiver cords on all coin collectors.

7. Instruction cards containing the central office name, station number and instructions for operating shall be placed on all coin collectors.

On coin collectors operating on a machine switching basis, the card containing the instructions for operating the coin collector shall be placed in the #1-B card holder (see section 44). Place the instruction card bearing the station number (Forms E-300 to E-305, see Specifications for Machine Switching Stations) on the dial.

On coin collectors operated on a manual basis, place the instruction card in the instruction card frame on the face of the coin collector. Do not use station number cards on the transmitters.

A temporary out of service card, Form E-158, shall be left with the public telephone agent to be used if service from the coin collector is found to be interrupted from any cause.

8. Keys and Switches. Do not install keys or switches which will remove coin collector from control of the Central Office or which will connect ground to line.

9. Subscriber's sets, used with #50 type coin collectors in common battery districts, shall have enclosed signaling gongs. This is not necessary in magneto districts.

When local battery talking is required for transmission reasons and is so specified by local supplementary instructions use a #534-Y subscriber's set and connect as shown in section 39.

ENTERING BUILDINGS

10. At stations with protectors, enter building, place protectors and terminate service wires in accordance with practices specified in specifications for Station and Private Branch Exchange Protector Installation.

11. At stations without protectors, enter buildings, place connecting blocks and terminate service wires in accordance with practices specified in specifications for Station Wiring.

LOCATING COIN COLLECTORS

12. When Service Order specifies location of coin collector use that location unless it conflicts with the rules given in section 13. In such case notify your supervisor and do not install coin collector unless instructed to do so. If Service Order does not specify location follow section 13.

LOCATING COIN COLLECTORS

13. General Rules. When location is not specified on Service Order place coin collector where desired by Public Telephone Agent or subscriber provided the location conforms to the following:

- (a) Coin collector must be easily accessible to the public. At public stations locate, if possible, where coin collector will be visible from entrance to store, room or hallway.
- (b) If practicable locate where there will always be sufficient light for dialing. If dial equipped coin collector is being installed where there is insufficient light, see section 45 for use of #35-A Dial Mounting. Where additional artificial light is to be provided, do not use the mounting.
- (c) Do not locate where users, installers or repairmen will be subject to injury or where the coin collector is liable to become damaged. Likely sources of hazard are:
 - (1) Doors, piled merchandise or other movable objects.
 - (2) Trap-doors near coin collector, stairs near coin collector leading down or other locations where user may be injured if he does not use care in going to or leaving coin collector.
 - (3) Coin collector placed less than 13 inches from a wall or other object on the same side as receiver. See section 18.
- (d) Do not locate coin collector—
 - (1) On plaster block walls unless no other location is available. (See section 21.)
 - (2) On wood lath or metal lath walls or on metal sheathed walls unless fasteners for backboard can be placed in solid wood backing, in studding, or in other framework according to sections 23 and 25.
 - (3) On a partition that may be vibrated to such an extent that the coin trigger will trip into operated position.
 - (4) On a round column.
 - (5) Where a person while using coin collector can come into contact with radiators or other grounded objects.
 - (6) Where dropping of receiver would injure glass show case or other similar property.
 - (7) In narrow passageways which would subject users and those passing to inconvenience and coin collector to possible damage.
 - (8) Near machinery likely to make noise.

- (e) Do not locate on a horizontal support unless coin collector can be securely fastened to such support and the support itself is firmly fastened in place so that it cannot be tilted or moved. Where necessary, fasten such support.
- (f) Avoid locating on finely finished surfaces such as marble counters or walls. If coin collector must be placed on such surfaces the consent to drill the surface shall be obtained from the Public Telephone Agent, subscriber or owner of building. If surface selected would be expensive to repair in case of the removal of the coin collector, installer shall consult his supervisor before proceeding with installation.
- (g) In booths, place the coin collector at standing height unless there is a permanent seat in the booth.

14. Height of coin collectors. Place coin collector so that center of transmitter (with face vertical) will be at the following heights above the floor:

For standing installations—56-1/2 inches.

For sitting installations—47-1/2 inches.

Use measurements given below which give approximately the correct height to transmitter.

WITHOUT BACKBOARD

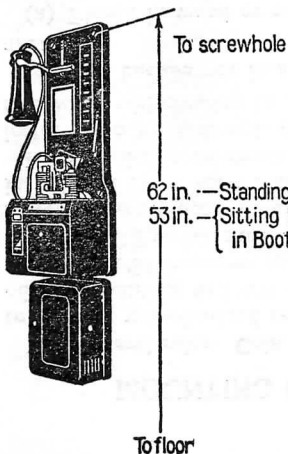

WITH BACKBOARD

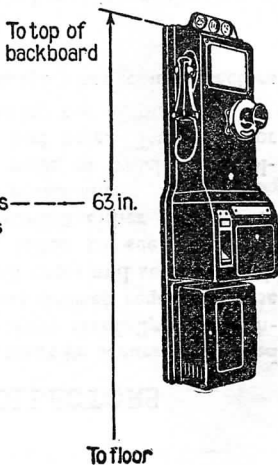

MOUNTING COIN COLLECTORS

15. General rules. Coin collectors must be securely fastened to prevent unauthorized removal. Follow carefully the methods of mounting and use of attaching devices required. Use the number of fasteners specified in all cases and see that each is secure. Special care should be taken to see that four fasteners are placed in coin compartment either at time of installation or as soon thereafter as practicable.

If in doubt as to construction of walls to which coin collector is to be fastened, drill small test hole. Turn drill or awl when withdrawing to avoid breaking out of plaster.

16. Use backboards in all cases except when coin collectors are:

- (a) Placed in wood or metal booths.
- (b) Placed on a flat and even vertical wooden surface upon which coin collector can be so mounted that edge all around will be in contact with surface without blocking out.

17. The number and location of fasteners depends on whether or not the installer has access to the coin compartment. Place fasteners as follows:

(a) When installer does NOT have access to Coin Compartment.

- (1) No backboard. Use 4 screws in upper part of coin collector. Screws in coin compartment will be added later by the collector.
- (2) #139-A Backboard. Use 4 machine screws through holes in upper part of coin collector. The machine screw in bottom of coin compartment will be added later by the collector.
- (3) #144-A Backboard. Use 6 bolts, but fasten with nuts on 4 bolts in upper part of coin collector only. Nuts on the bolts in the coin compartment and the 2 screws will be added later by the collector.
- (4) #144-B Backboard. Use 4 screws in upper part of coin collector. The 4 screws in coin compartment will be added later by the collector.

- (b) When installer HAS access to Coin Compartment.
- (1) No backboard. Use 2 screws in top holes of coin collector and 4 screws in coin compartment.
 - (2) #139-A Backboard. Use 4 machine screws in holes in upper part of coin collector and 1 machine screw in hole in bottom of coin compartment.
 - (3) #144-A Backboard. Use 2 bolts in top holes of coin collector and 2 bolts and 2 screws in coin compartment.
 - (4) #144-B Backboard. Use 2 screws in top holes of coin collector and 4 screws in coin compartment.

18. In mounting coin collectors where backboards are not required (see section 16) locate top right-hand hole by measuring as shown below and make 1/8 in. starting hole for screw.

In booths which have been equipped with bolts, but from which the bolts have been removed, place coin collector 1/2 inch higher so that screws clear both holes.

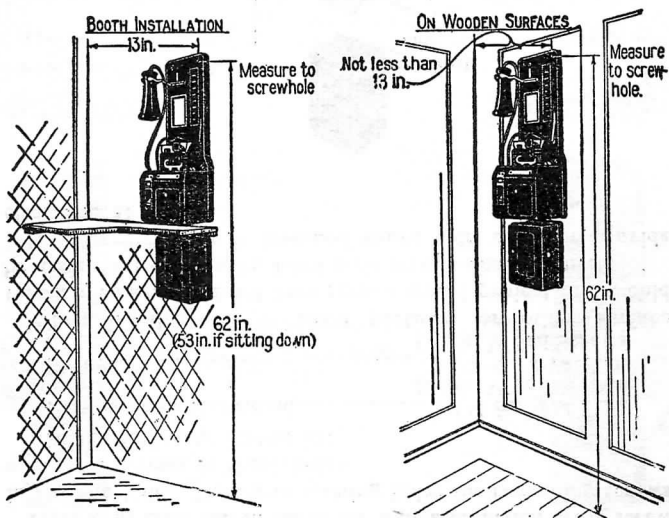

MOUNTING COIN COLLECTORS

Hold coin collector in place on wall and fasten with screw in starting hole. Then drill starting holes for remaining screws and place screws in these holes.

Use the following screws in:

Booths or in Hardwood	1-1/4 in. #14 F.H.
	Bright Wood Screws
Softwood	1-3/4 in. #14 F.H.
	Bright Wood Screws

When installed on softwood partition or other surface through which the 1-3/4 inch screws would project and would be visible on other side, 1-1/4 inch screws shall be used.

If subscriber's set is installed above coin collector provide clearance as shown.

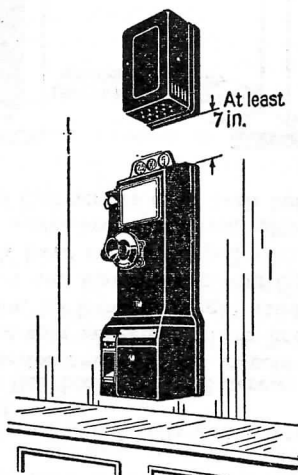

When mounting coin collectors in metal open type booths use screws furnished with booth. Holes are drilled in back of booth for mounting purposes.

19. When mounting coin collectors on horizontal surfaces use a #139-A Backboard. If support upon which the backboard is to be mounted can be easily tilted or moved, it must be securely fastened by using iron corner braces, screws or other suitable means.

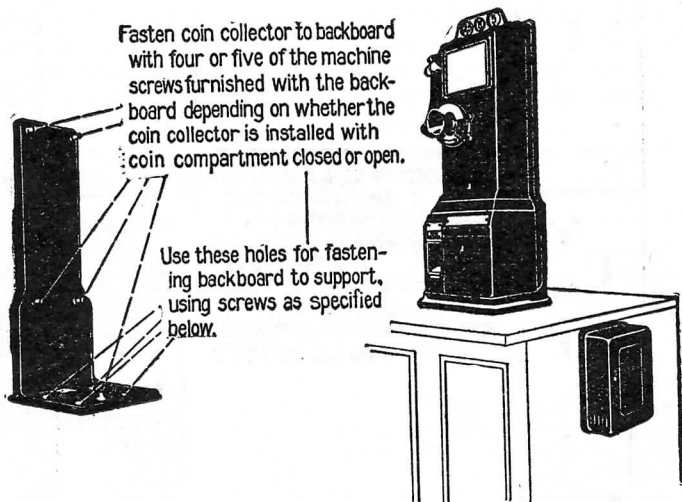

Fasten backboard with 4 screws as follows :

On wood	1-1/4 in. #14 F.H. Bright Wood Screws.
On marble or other masonry	1-1/2 in. x 1/4-20 F.H. Bright Machine Screws in 1/4 in. Machine Screw Anchors or approved equivalent.

MOUNTING COIN COLLECTORS

20. When mounting coin collectors on walls where backboards are required (see section 16) use #144-type backboards. If lower part of #144-type backboard must be removed because of wall obstructions or for other reasons, saw off along saw cut. If backboard is required for subscriber's set the sawed-off portion may be used for the installation of the set provided the sawed-off edge will not be too conspicuous.

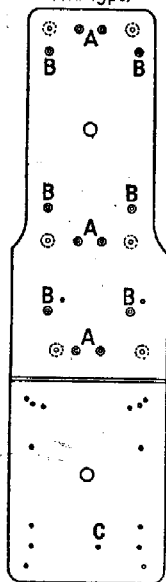
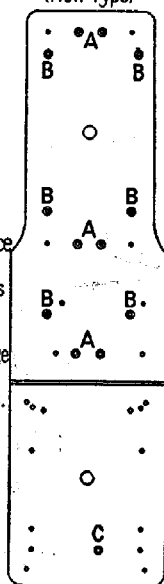
#144-A Backboard
(Old Type)#144-B Backboard
(New Type)

A, B, C holes are for mounting backboard to supporting surface. Other holes are for mounting coin collector and subscriber's set to backboard. Coin collector is mounted on #144-A backboard with carriage bolts and on the #144-B backboard with woodscrews. See Section 26.

Fasten backboards to supporting surfaces in accordance with the following sections.

In all cases use six fastening devices in A or B holes in upper part of backboard.

Do not place a fastening device in C hole unless bottom of backboard is not flush with the supporting surface or there is danger of the backboard warping. In such cases use the same type of fastening device in the C hole as is used in the upper part of the backboard or an approved equivalent.

Drill holes for anchors deep enough to permit full penetration of screws. This is usually 1/4 inch to 1/2 inch greater than the depth required for the anchor.

21. Fastening #144 backboards to masonry walls. See section 20 for designation of holes.

MASONRY NOT PLASTERED

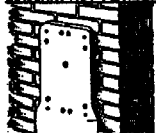

Use 2 in. x 1/4-20 F.H. Bright Machine Screws in 1/4 in. Machine Screw Anchors through holes B. Place anchors flush with face of masonry.

GLAZED TILING ON BRICK



Use 3 in. x 1/4-20 F.H. Bright Machine Screws in 1/4 in. Machine Screw Anchors through holes B. Use 17/32 in. twist drill for drilling holes through tile. Drill bricks with 1/2 in. star faced drill. Place anchors flush with face of brick.

MARBLE

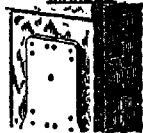

Use 2 in. x 1/4-20 F.H. Bright Machine Screws in 1/4 in. Machine Screw Anchors through holes B. Use 17/32 in. twist drill for drilling holes through marble. Drill bricks with 1/2 in. star faced drill. Place anchors flush with face of marble.

MASONRY-PLASTERED

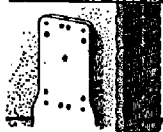

Use 3 in. x 1/4-20 F.H. Bright Machine Screws in 1/4 in. Machine Screw Anchors through holes B. Use 17/32 in. twist drill for drilling holes through plaster. Drill bricks with 1/2 in. star faced drill. Place anchors flush with face of brick.

MOUNTING COIN COLLECTORS

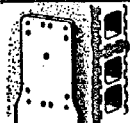
HOLLOW TILE-PLASTERED

Use $\frac{3}{16}$ in. x 4 in. B.H. Toggles through holes B. Use $\frac{17}{32}$ in. twist drill for drilling holes through plaster. Drill hollow tile with $\frac{1}{2}$ in. star faced drill. If solid part of tile is struck tilt drill toward hollow part.

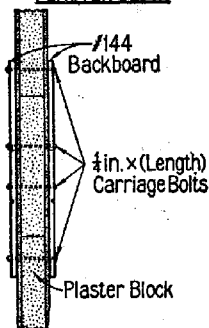
PLASTER BLOCK

Place backboards on both sides of wall and fasten through with seven $\frac{1}{4}$ in. x (length) carriage bolts through holes B and C. Place nuts on side where coin collector is mounted. Cut off excess length of bolt. Use $\frac{1}{4}$ in. twist drill for making holes through walls.

22. Locating studding or furring on wood or metal lath walls.

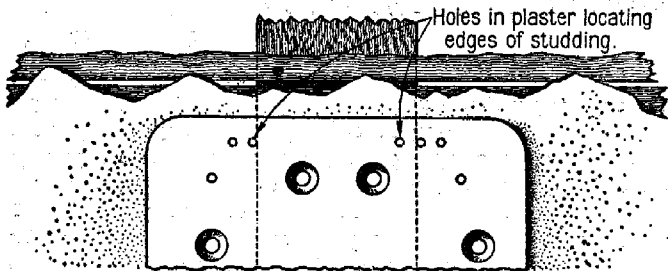

- 1st. Approximately locate studding or furring by sounding.
- 2nd. Locate both edges of studding or furring by drilling test holes.
- 3rd. Center backboard over studding or furring.

23. Fastening #144 backboard to wood lath and metal lath walls. See section 20 for designation of holes.

WOOD OR METAL LATH ON STUDDING

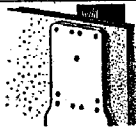

Fasten backboard to studing with 3-1/2 in. #14 F.H. Bright Wood Screws through holes A.

WOOD OR METAL LATH ON FURRING

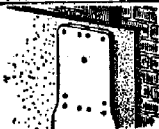

Fasten backboard to furring with 2-1/2 in. #14 F.H. Bright Wood Screws through holes A.

METAL LATH ON METAL FRAMEWORK

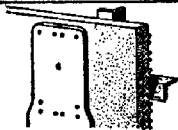

Use 3/16 in. x 4 in. B.H. Toggles in holes B. Use 11/32 in. twist drill for drilling holes through tile, then enlarge holes by using 5/8 in. twist drill.

GLAZED TILE ON METAL LATH



MOUNTING COIN COLLECTORS

24. Locating studding or furring on metal-sheathed walls. The approximate location of studding or furring, which is not evident from nails fastening baseboards, may be determined as follows:

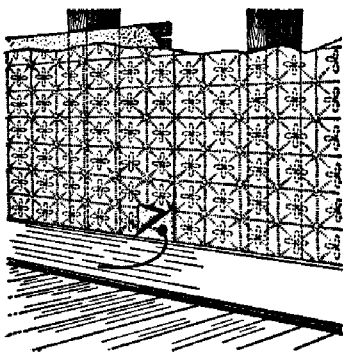

- (a) If seam of metal sheathing runs vertically, open a seam at baseboard (near location selected for coin collector) for a distance of about 6 inches and bend back the metal. If metal sheathing runs horizontally, cut a small vertical slit in metal at baseboard.
- (b) Drill 1/2 in. hole through backing into space behind.
- (c) Use fish wire to locate studding or furring.
- (d) Mark fish wire at hole, pull out and measure distance from mark to end. Then place backboard over studding or furring.

After locating studding or furring, replace and fasten sheathing carefully so that no edges are left to injure anyone cleaning baseboard or passing close to it.

Where there is molding above baseboard it may be possible to raise molding and bore hole where it will be hidden when molding is replaced. In such cases do not bend back metal but bore through it.

25. Fastening #144 backboard to metal-sheathed walls.
See section 20 for designation of holes.

If sounding shows backing to be solid, bore into it to determine the nature of the material.

METAL SHEATH ON $\frac{7}{8}$ IN. SOLID WOOD

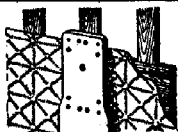

If of wood and $\frac{7}{8}$ inch or more thick fasten backboard to wood using 1- $\frac{3}{4}$ in. #14 F.H. Bright Wood Screws through holes B. Be sure that screws do not enter space between boards. In some walls backing is only shoulder high. In such cases place backboard so that upper holes A are centered over furring as shown. Place screws through holes over furring instead of through holes B.

If wood is less than $\frac{7}{8}$ inch thick, fasten backboard to the wall behind the wood after you have determined the nature of the material.

METAL SHEATH ON $\frac{1}{2}$ IN. SOLID WOOD OVER LATH AND PLASTER ON $\frac{1}{4}$ IN. FURRING

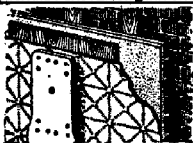

Fasten backboard to furring with 3 in. #14 F.H. Bright Wood Screws through holes A.

METAL SHEATH ON $\frac{1}{2}$ IN. FURRING OVER BRICK WITH PLASTER BETWEEN



Fasten backboard to brick wall with 3 in. x 1/4-20 F.H. Bright Machine Screws in 1/4 in. Machine Screw Anchors through holes B. Place anchors flush with face of brick.

MOUNTING COIN COLLECTORS

METAL SHEATH ON 1/2 IN. SOLID WOOD
OVER BRICK



Fasten backboard to brick wall with 2-1/2 in. x 1/4-20 F.H. Bright Machine Screws in 1/4 in. Machine Screw Anchors through holes B. Bore 5/8 in. or 3/4 in. holes through sheet metal and wood. Drill masonry with 1/2 in. star faced drill. Place anchors flush with face of brick.

METAL SHEATH ON 1/2 IN. FURRING
OVER LATH AND PLASTER



METAL SHEATH ON 1/2 IN. FURRING
OVER LATH WITH PLASTER BETWEEN

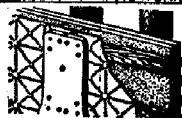

Fasten backboard to studding with 3-1/2 in. #14 F.H. Bright Wood Screws through holes A.

METAL SHEATH ON LATH
AND PLASTER

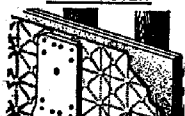

METAL SHEATH ON 1/2 IN. SOLID
WOOD OVER LATH AND PLASTER

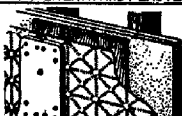

METAL SHEATH ON BRICK



Fasten backboard to brick wall with 2 in. x 1/4-20 F.H. Bright Machine Screws in 1/4 in. Machine Screw Anchors through holes B. Place anchors flush with face of brick.

METAL SHEATH OVER LATH
AND PLASTER ON 1/2 IN. FURRING

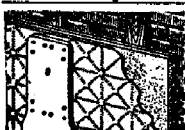

METAL SHEATH ON 1/2 IN. FURRING
OVER LATH WITH PLASTER BETWEEN



Fasten backboard to furring with 2-1/2 in. #14 F.H. Bright Wood Screws through holes A.

26. Fasten coin collector and subscriber's set to backboard as shown below.

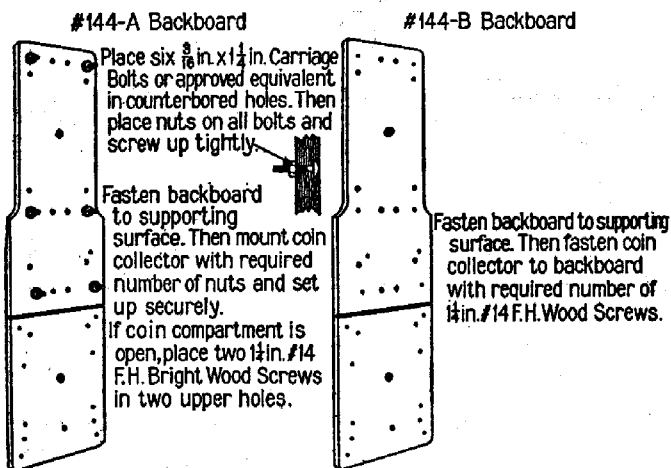

WIRING

27. **Selection of wire.** Use inside wire except in damp places, where bridle wire should be used. At stations without protectors, where appearance is not important, run service wire directly to collector.

Select wire as shown below:

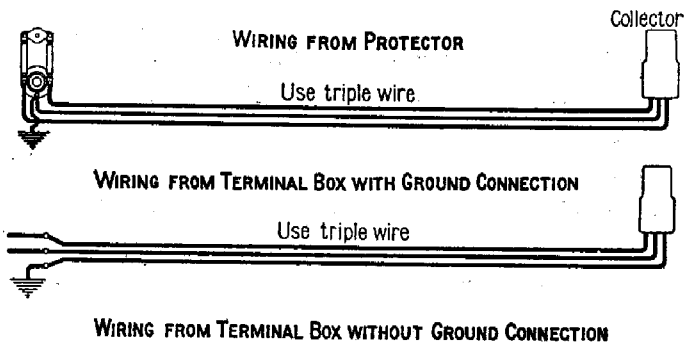

Consider terminal box as a connecting block and treat as shown on next page.

**STATIONS
No. 50 COIN
COLLECTOR
INSTALLATION**

WIRING

SERVICE WIRE RUN DIRECTLY TO COIN COLLECTOR

If the service wire is run direct to coin collector, use single inside wire from coin collector to ground connection.

CONVERTING POSTPAYMENT STATION TO PREPAYMENT STATION

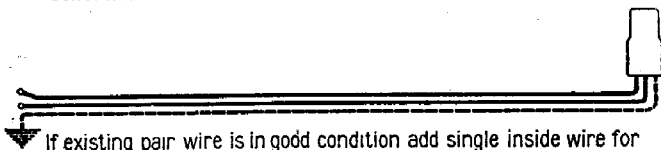

If existing pair wire is in good condition add single inside wire for ground connection.

**WIRING FROM CONNECTING BLOCKS
WHEN SERVICE AND GROUND WIRES RUN IN SAME DIRECTION**

If ground is nearer connecting block than coin collector, but beyond the block, use a three post connecting block. Run triple wire from coin collector to block, and single inside wire from block to ground connection.

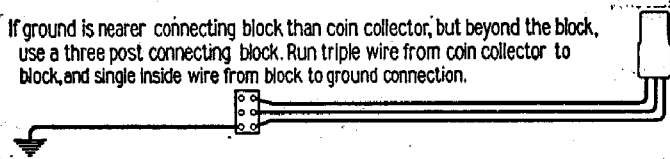

If ground is nearer connecting block than coin collector, but between the block and collector, use a two post connecting block. Run triple wire from coin collector to block. Untwist yellow or plain conductor and run to ground connection.

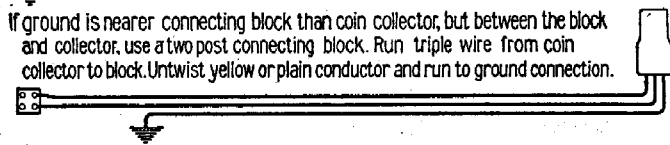

If ground is nearer coin collector than connecting block, use two post connecting block. Run pair wire from coin collector to block and single inside wire from coin collector to ground connection.

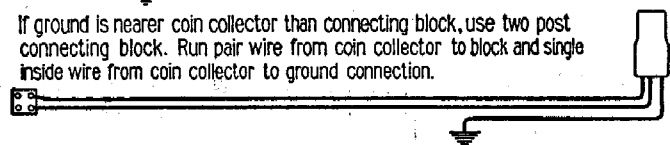

WHEN SERVICE AND GROUND WIRES ARE NOT RUN IN SAME DIRECTION

Use two post connecting block and run pair wire from coin collector to block, and single inside wire from coin collector to ground connection

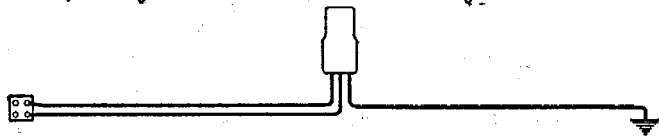

28. Install all wiring in accordance with practices specified in specifications for Station Wiring.

Whenever practicable, conceal wiring near coin collector. Where this cannot be done, tape wires with friction tape. Locate connecting blocks and protectors so that they will not be accessible to a person while he is making a call from the coin collector. At installations such as in contractors' shanties this may necessitate placing the protector outside the shanty. See specifications for Station and Private Branch Exchange Protector Installation.

29. Multiple installations not in booths. Where several coin collectors are installed in the same room, treat each coin collector as a separate installation with its own signaling ground wire, except that two ground wires when run to the same point may be terminated on one ground clamp.

30. Installations in booths.

SINGLE INSTALLATIONS.

Installations in open type booths shall be made in the same manner as if the coin collector were mounted on the wall. At installations in #1 or #2 type booths leave about 8 inches of slack in triple wire on top of booth ceiling for ground wire connection to #12-C connecting block which will be installed in case of growth. If pair wire and single inside wire are used, leave slack in single wire only.

MULTIPLE INSTALLATIONS.

Where coin collectors are installed in a group of booths (two or more booths) proceed as follows:

- (a) Select first booth (called entrance booth in figures below) into which wiring is to be run.
- (b) Select wire for this booth according to section 27.
- (c) If triple wire is selected, wire installation as below. One ground wire is sufficient with this wiring for a group of 6 booths.
- (d) For the other booths in the group, run pair wires from connecting block, protector or building cable terminal to coin collectors and single inside wire from coin collectors to #12-C connecting block on top of booth ceiling to which the signaling ground is attached.

WIRING

If initial installation consists of less than 6 booths in one group but through growth this number is increased to more than 6 booths, a second #12-C connecting block (shown dotted in figure) should be added to care for ground connections from the additional booths. Wire additional booths in same manner as described above for the initial installation. One signaling ground wire should be run for each 6 booths. Two ground wires may be terminated on one ground clamp.

Connecting Block, Protector,
or Cable Terminal.

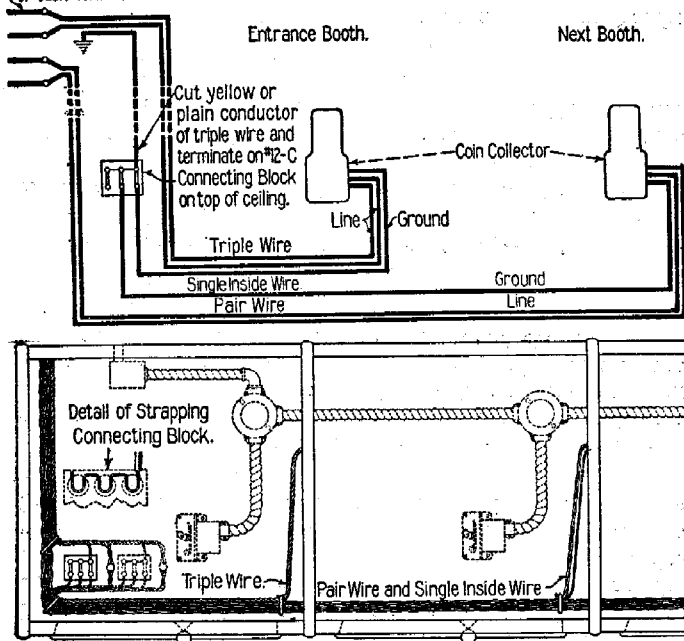

- (e) If pair wire and single inside wire are selected for entrance booth, run single wire from #12-C connecting block on top of booth ceiling to coin collector for ground, and pair wire from coin collector to connecting block or cable terminal.

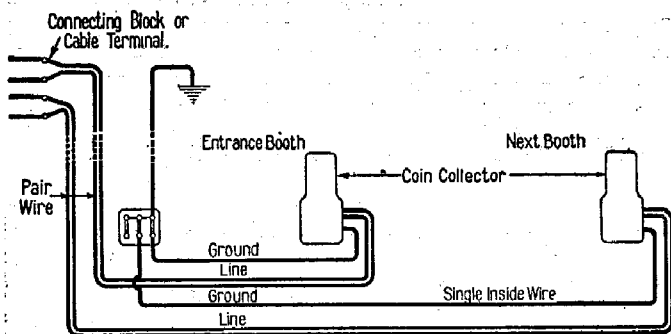

Where coin collectors are installed in a group of open type booths, proceed as above except that connecting block for ground connection must be mounted near the booths in a location accessible for testing but not accessible to a person using a booth. When cable is used, select a connecting block as outlined in section 31 and mount it in a building cable terminal of proper size.

31. Run cable instead of wire if the initial installation consists of 6 or more booths in one group or if there are 4 or more booths in one group and

- (a) Appearance will not permit the use of wires.
- (b) Conduit is available but is too small to take required number of wires.
- (c) Extensive or difficult fishing in wall or partition would be required.

Where cable is used, run #14 ground wire from connecting block on top of booth ceiling to ground clamp, unless:

- (a) Terminal or cross-connecting box to which cable is run is provided with or is near a ground connection.
- (b) Conditions are such that running of a separate ground wire is impracticable.

Under such conditions use a cable pair for signaling ground wire from connecting block on top of booth ceiling to terminal or cross-connecting box for each 6 or less booths.

In determining the size of cable to use consider the possibilities of growth.

**STATIONS
No. 50 COIN
COLLECTOR
INSTALLATION**

WIRING

Use	or approved equivalent	for	MAXIMUM CAPACITY	
			Using Separate Ground Wire	Cable Pair Used for Ground
6 pair U cable	}	4 or 5 Booths	4	Booths
11 " " "		6 to 10 "	5 to 9	"
16 " " "		11 to 15 "	10 to 13	"

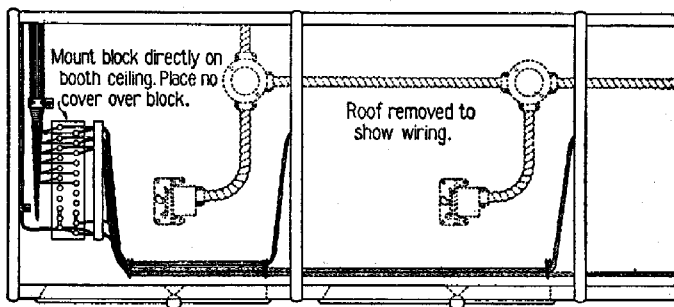
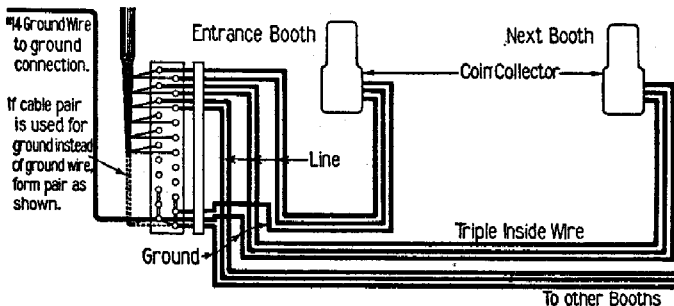

Use	For
#30-B Connecting Block (11 pairs)	6 pair U Cable
#30-C Connecting Block (16 pairs)	11 pair U Cable
#30-D Connecting Block (21 pairs)	16 pair U Cable

32. Make ground connection for signaling ground at stations without protectors in accordance with specifications for Station Wiring. At stations with protectors, run signaling ground wire to protector ground post.

33. Terminate wires at the coin collector as follows:

When pair wire and single wire are used for line and ground, run single wire into coin collector and pair wire into subscriber's set.

When triple inside wire is used for line and ground, run red and green tracer wires into subscriber's set and yellow tracer wire into coin collector. When triple bridle wire is used, run tracer wires into subscriber's set and plain wire into coin collector.

Run triple wire from set to coin collector and terminate as shown in section 37.

Place a tag attached to the ground wire in the coin collector, giving location of ground and station number.

No. 50 COIN COLLECTORS OPERATING ON POSTPAYMENT BASIS

34. Wiring. When the #50 coin collector is operated on postpayment basis, no signaling ground is necessary. Where coin collector may later be converted to prepayment operation, the selection of wire should be made according to section 27. The districts where this should be done will be specified in supplemental local instructions. Otherwise select wiring as for individual or party line, according to specifications for Station Wiring.

At installations of postpayment #50 coin collectors where wiring is selected in accordance with section 27, terminate wires as follows:

At point of Entrance:

- (a) Where wire is run to a protector, terminate red and green tracer wires on right and left line posts respectively. Coil the yellow tracer or plain wire, leaving enough slack to reach to ground post, but do not connect it to post.
- (b) Where triple wire is run to connecting block, terminate wires from coin collector on block but do not connect ground wire on block.
- (c) When pair and single wire would be selected, run pair wire to block. Single wire for ground may be run either when coin collector is installed or when it is converted.

At Coin Collector:

Terminate wires in accordance with section 33.

#50 COIN COLLECTORS OPERATING ON POSTPAYMENT BASIS

35. Special arrangement of #50-G coin collectors for post-payment operation. Where #50-G coin collectors are specified by local supplemental instructions (see section 3) for use as a postpayment coin collector it shall be arranged for such service as shown below:

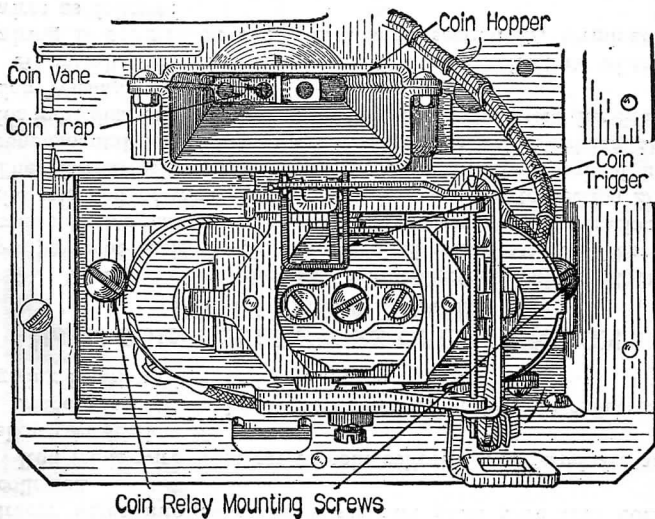

1. Remove coin relay mounting screws and raise coin relay until coin vane pin is released from between the fingers of the operating arm.
2. Let coin vane fall toward the left (facing coin collector) so that coins deposited will fall directly into the coin receptacle.
3. Replace coin relay and tighten coin relay mounting screws. The operating arm will then be on the right of the coin vane pin and will serve to prevent the coin vane from being accidentally shifted to a point which will allow coins to fall into the coin return compartment instead of into the coin receptacle.
4. Take the relay out of the circuit by disconnecting the black wire from the right hand relay terminal and fasten it with the blue wire under the screw on the ground spring contact assembly.

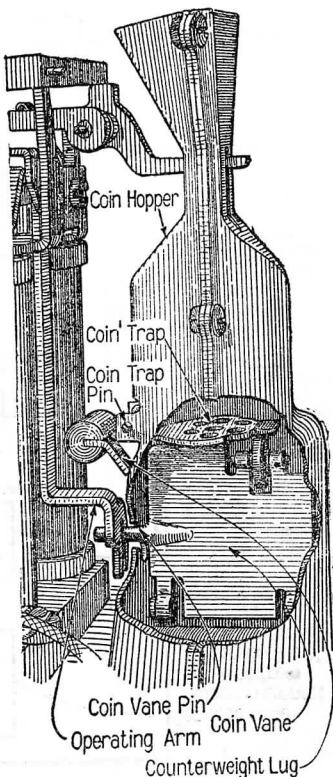

CONNECTIONS

36. Use of side tone reduction circuit. Use side tone reduction circuit on all coin collectors except in step-by-step areas or where local battery talking is used, in accordance with specifications for Manual Stations. Connect coin collectors for side tone reduction as shown in section 37.

In step-by-step areas, because of the type of central office circuits, side tone reduction is not required except under special conditions as may be covered by supplemental instructions.

CONNECTIONS

37. Below are diagrams showing connections of #50 coin collectors and associated subscriber's set now in use on individual lines. Diagrams shown are arranged for central offices having positive side of central office batteries grounded. Changes to be made when negative side of central office battery is grounded are specified in section 38.

#50-A AND F COIN COLLECTORS—MANUAL PREPAYMENT OPERATION.

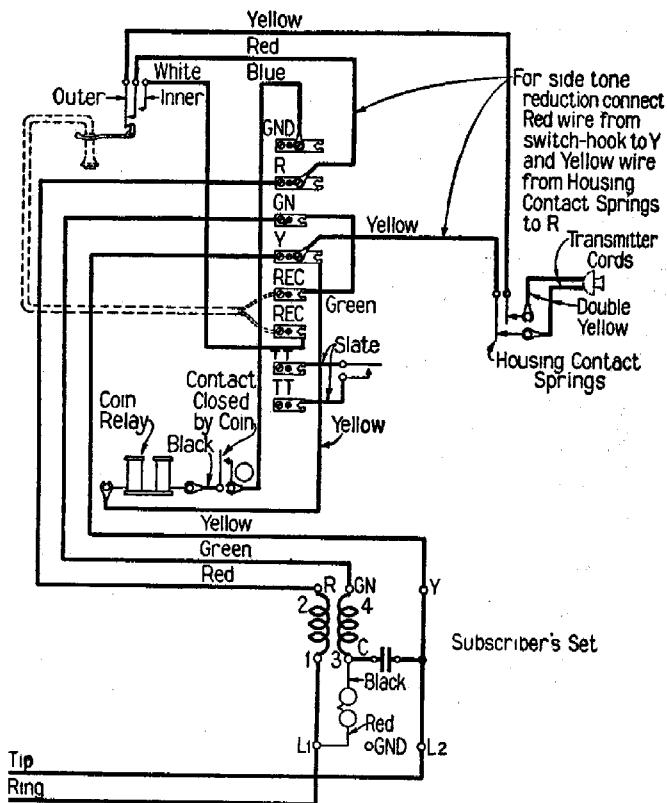

#50-G AND H COIN COLLECTORS—MANUAL PREPAYMENT OPERATION

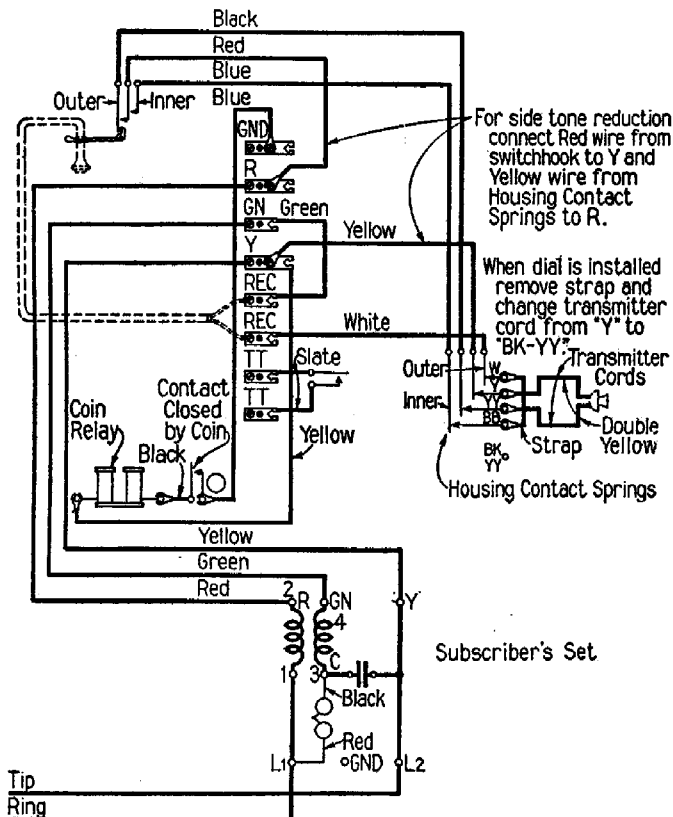

CONNECTIONS

#50-G AND H COIN COLLECTORS—MACHINE SWITCHING PREPAYMENT OPERATION.

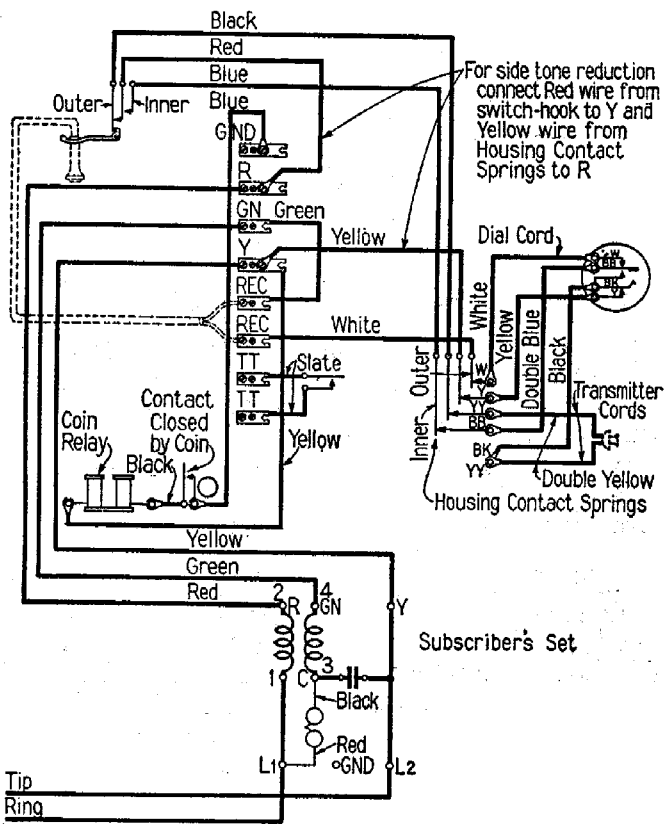

#50K AND L COIN COLLECTORS—MANUAL POSTPAYMENT OPERATION. COMMON BATTERY AND MAGNETO.

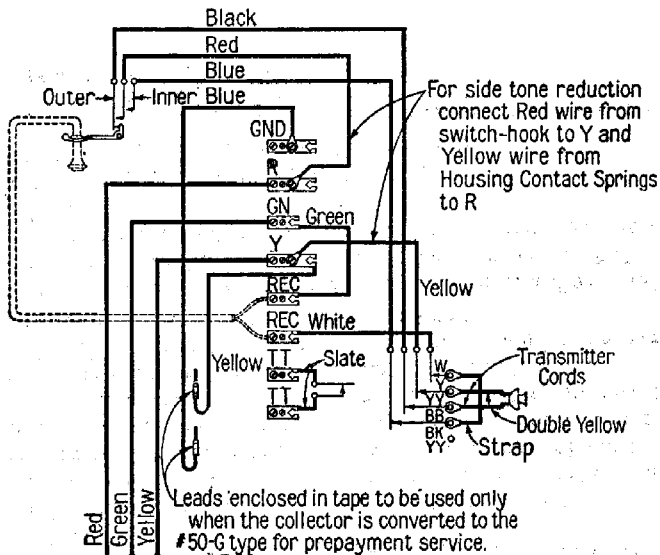

To Fig. A or B

Fig. A - Common Battery

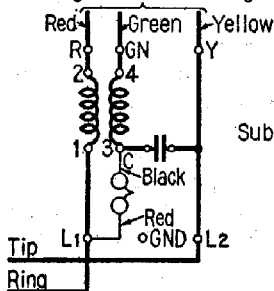
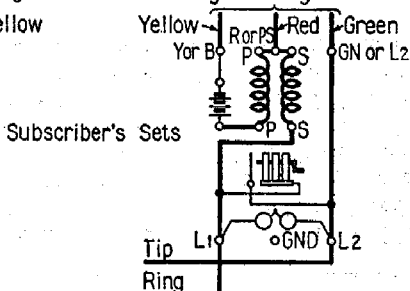

Fig. B - Magneto



**STATIONS
No. 50 COIN
COLLECTOR
INSTALLATION**

CONNECTIONS

38. Negative side of Central Office battery grounded. New prepayment coin collectors have connections made to function with the positive side of the central office battery grounded. If a coin collector so connected is installed in a district where the negative side of the central office battery is grounded, electrolytic corrosion will set up in the relay coils. It is necessary, therefore, to change the relay coil connections in such cases. Referring to circuits on previous pages make the following changes:

- (a) Disconnect yellow lead from left relay terminal.
- (b) Transfer black lead from right relay terminal to left relay terminal.
- (c) Transfer blue lead from outside spring terminal to right relay terminal.
- (d) Connect yellow lead to outside spring terminal.

Make these changes only at new coin collector installations in central office districts having the negative side of the battery grounded and when an existing coin collector line is cut over from a central office with a positive battery ground to a central office with a negative battery ground.

No wiring changes are necessary when changing an area from negative ground to a positive ground.

39. Where local battery talking is required at a #50-G coin collector installation for transmission reasons, use a #534-Y subscriber's set and modify coin collector circuit as shown below:

MANUAL PREPAYMENT OPERATION.

Referring to circuit on page 35, section 37,

- (a) At connecting block transfer yellow coin relay wire from Y lug to GN lug.

Modified circuit is shown below.

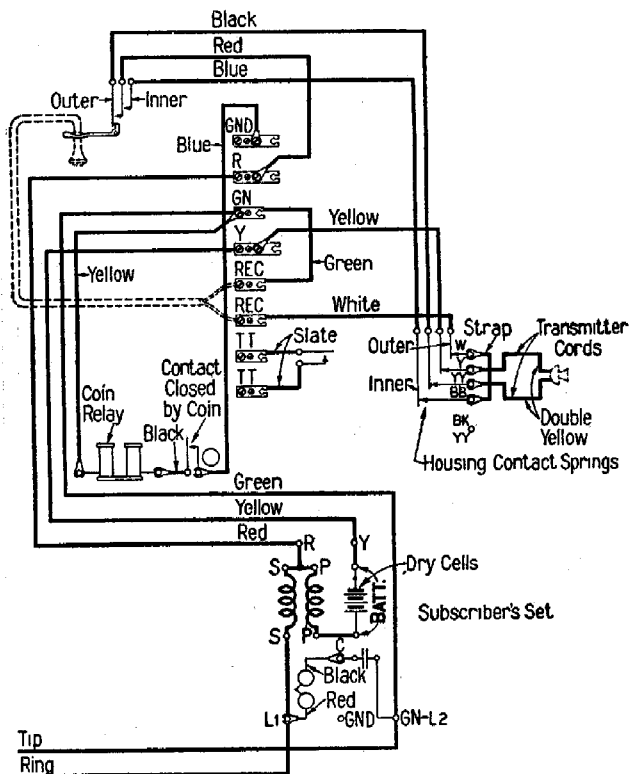

MACHINE SWITCHING OPERATION.

Referring to circuit on page 36, section 37,

- (a) At contact spring (cover side) disconnect "W" wire, tape and tie in form. Transfer "BK" wire from "YY-BK" terminal to "W" terminal. Add strap between "BB" and "YY-BK."
- (b) At connecting block transfer yellow coin relay wire from "Y" lug to "GN" lug. Remove green wire between upper "REC" lug and "GN" lug. Yellow wire from contact spring "Y" normally connected to "Y" lug to be transferred to "GN" lug.

**STATIONS
No. 50 COIN
COLLECTOR
INSTALLATION**

CONNECTIONS

(c) At switchhook disconnect black wire from outer spring and connect it to "Y" lug on connecting block.

Disconnect blue wire from inner spring and transfer it to outer spring.

Connect inner spring with new wire to upper "REC" lug on connecting block.

Modified circuit is shown below.

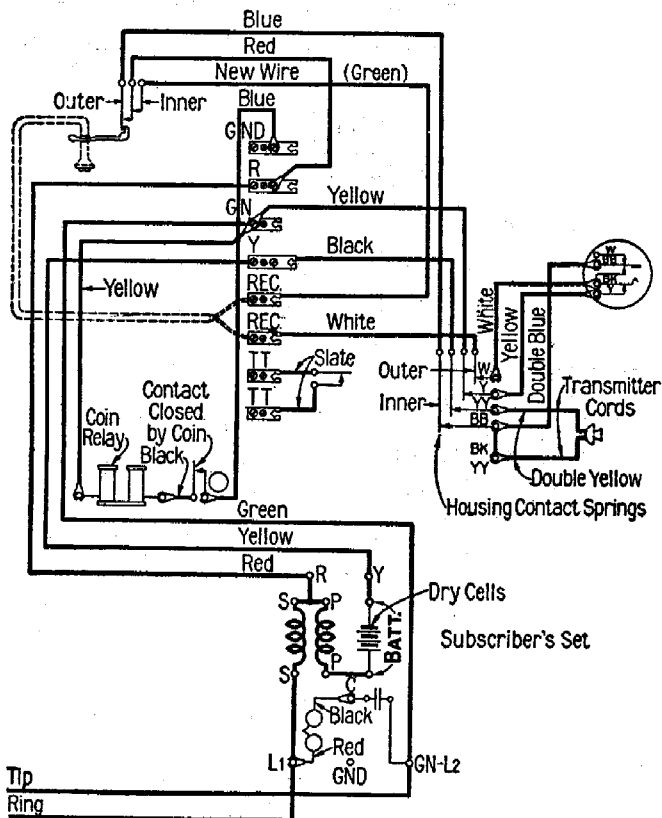

CONVERSIONS

40. Converting a #50-A or F Coin Collector for Machine Switching Operation. (If required by supplemental instructions.) Remove housing and referring to circuit for #50-A and F coin collectors, section 37, page 34, proceed as follows:

- (a) Disconnect white wire at switchhook and REC terminal.
- (b) Disconnect yellow wire at switchhook.
- (c) Disconnect clip of yellow wire (from housing contact springs) from Y terminal on connecting block.
- (d) Unlace form, take out white wire and remove housing contact spring assembly with two yellow wires attached.
- (e) Install new housing contact spring assembly. Assembly is furnished with wires attached.
- (f) Solder wires from spring assembly as follows:
Black wire to outer terminal of switchhook.
Blue wire to inner terminal of switchhook.
White wire to lower REC terminal on connecting block.
- (g) Connect yellow wire clip to "Y" terminal on connecting block.
- (h) Place wires in form and lace up form.
- (i) Place housing equipped with dial and #1-B card holder on coin collector. For mounting dial and card holder see sections 43 and 44.
- (j) Mount instruction card on #1-B card holder and make tests for operation in accordance with sections 46 to 54.
- (k) Change circuit label.

41. Converting #50-G or H Coin Collectors from Manual to Machine Switching Operation. (If required by supplemental local instructions.) Referring to circuits for #50-G and H coin collectors for manual operation, section 37, pages 35 and 36, proceed as follows:

- (a) Remove upper housing from coin collector.
- (b) Remove coin chute and apparatus blank from housing. See section 43. (Handle coin chute carefully to avoid damage.)
- (c) Remove wire strap connecting terminals "W" and "BB" in upper housing.
- (d) Change transmitter cord from terminal "Y" to terminal "BK-YY" in upper housing.
- (e) Install dial, dial cord and #1-B card holder on housing. See sections 43 and 44.
- (f) Replace coin chute.
- (g) Replace upper housing on coin collector and make tests for operation. See sections 46 to 54.
- (h) Mount instruction card in #1-B card holder.

CONVERSIONS

42. Converting #50-K or L Coin Collector from Postpayment to Manual Prepayment Operation. (If required by supplemental local instructions.) Referring to circuit for #50-K and L coin collector, section 37, page 37, proceed as follows:

- (a) Remove upper housing.
- (b) Remove hopper as shown below. Access must be had to coin compartment.
- (c) Place prepayment coin hopper assembly and coin relay.
- (d) Connect coin relay leads (found taped in the form in back of hopper) as follows:

Where positive side of Central Office battery is grounded:

Blue wire from GND terminal on connecting block to outer ground contact spring.

Yellow wire from Y terminal on connecting block to terminal on left relay coil.

Where negative side of Central Office battery is grounded connect as outlined in section 35.

- (e) Replace housing and make tests for operation in accordance with section 46 to 54.
- (f) Change instruction card and code number plate.
- (g) Change circuit label.

These operations make the coin collector in effect a #50-G or H collector. In converting this coin collector to machine switching operation follow section 41.

To remove hopper, remove these three screws
In placing the prepayment coin hopper assembly use same three screws for fastening assembly to tray

Fasten coin relay unit to tray with screws furnished with relay unit

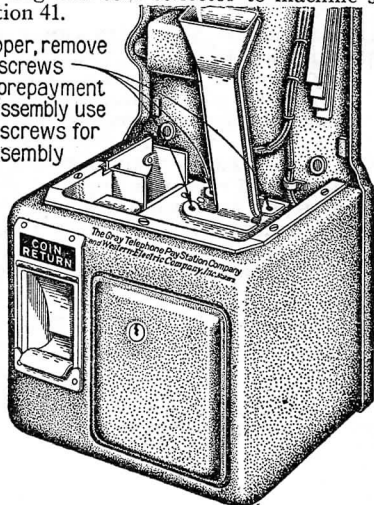

43. Install dial on the #50-G or H coin collectors as follows :

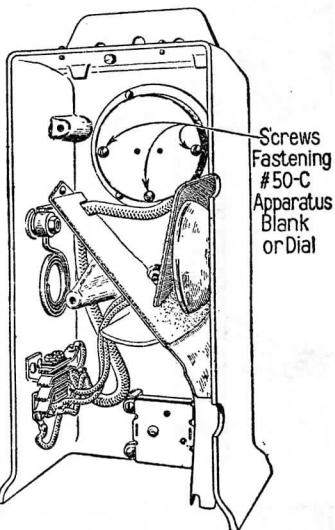

- (a) Remove coin chute, using care to avoid damage.
- (b) Remove #50-C Apparatus Blank by loosening the three screws shown.
- (c) Install dial cord on dial.
- (d) Insert free end of dial cord through hole in housing and place dial. Fasten dial with the screws in back of cup.
- (e) Run cord under cup and through baffle plate and connect on housing contact assembly.
- (f) Replace coin chute.

Upper Housing with Coin Chute removed

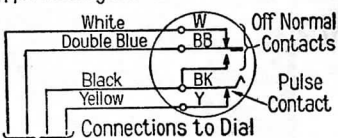

Note: To replace dial on housing it is not necessary to remove chute.

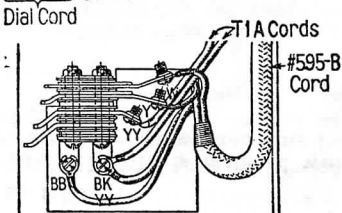

Connecting #595-B Cord and T1A Cords to Housing Contact Assembly

CONVERSIONS

44. Install #1-B Card Holder on coin collectors operating on a machine switching basis as follows:

- (a) Remove code number plate. If plate is fastened with machine screws and nuts, use these screws and nuts for fastening card holder and plate.

If plate is fastened with rivets, file off heads and drive rivets through.

Be sure rivets do not lodge in coin chute.

Be careful not to break housing or damage finish of coin collector. If fastened with rivets, ream out holes of plate and coin collector with a #31 drill.

- (b) Place base of card holder in space formerly occupied by code number plate.

Place plate on top of base of card holder.

Fasten both to housing, using four P-201135 R.H. slotless machine screws and P-165486 hexagon nuts for these screws. Place lock washers between heads of machine screws and code number plate as shown. Place nuts inside of housing.

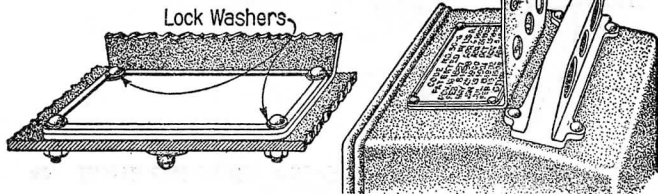
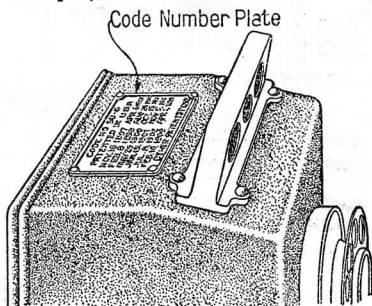

45. Install #35-A Dial Mountings on coin collectors operated on a machine switching basis and which are located in booths or other places where there is not sufficient (natural or artificial) light for dialing (and additional artificial light is not to be provided). This mounting is reversible and should be placed so that the dial will face the light.

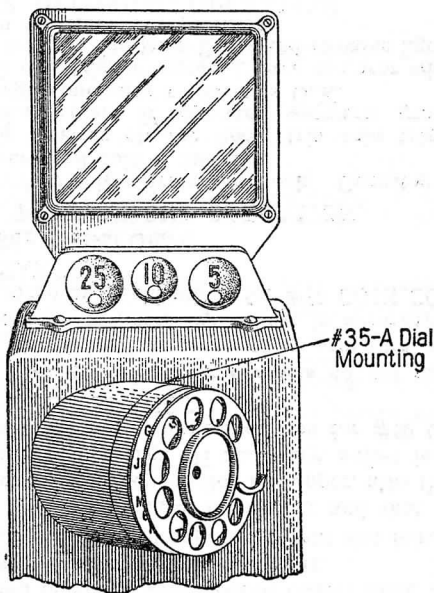

Fasten dial to mounting, using 3 screws furnished with mounting.

Then fasten mounting to coin collector, using 3 screws ordinarily used for fastening dial to coin collector. The lower screw should be tightened before the two upper screws.

TESTS AND ADJUSTMENTS

46. Make tests as given for manual practice in accordance with specifications for MANUAL STATIONS. In addition make the following tests on the coin collector:

47. See that signal gongs are tight and that receiver cord is fastened and is clear of gongs.

See that indicating mark on the solid gong coincides with the mark on the edge of the housing. If necessary, adjust gongs to obtain this result.

Test sound of gongs with Central Office, using 5, 10 and 25 cent pieces in their respective coin slots.

See that 1 cent piece dropped in 5 cent slot is rejected.

48. See that coin trigger is straight and that it does not touch either sides or top of slot in hopper, also that the coin vane is centered properly. If necessary, adjust in accordance with instructions given in specifications for #50 COIN COLLECTOR MAINTENANCE.

49. See that ground spring contacts do not make contact when the coin trigger and the relay armature are in their normal position. If necessary, adjust in accordance with instructions given in specifications for #50 COIN COLLECTOR MAINTENANCE.

50. Calling Central Office.

MANUAL PREPAYMENT OPERATION.

- (a) Remove receiver from the hook. Operator should not answer until coin is inserted.
- (b) With receiver off the hook, trip coin trigger by depositing coin. If operator answers, ground circuit through coin relay contacts is O. K.
- (c) With coin trigger operated, have operator withdraw plug and see that line lamp lights and remains lighted steadily when switchhook is operated.

MACHINE SWITCHING OPERATION.

- (a) Remove receiver from hook. Dial tone should be received.
- (b) If dial tone is received, deposit coin and dial station number. If busy line signal is received, circuit is O. K.

51. Test of coin relay. With receiver on switchhook connect test set across (R or 2) and (Y or L2) terminals of coin collector. Trip coin trigger with finger and request operator or test desk operator to depress "return" and "collect" keys successively, then remove clips of test set.

See that relay armature operates positively and in the right direction.

Any adjustment needed should be made in accordance with instructions given in specifications for #50 COIN COLLECTOR MAINTENANCE.

52. Test operation of dials on coin collectors working on machine switching basis in accordance with instructions given in specifications for MACHINE SWITCHING STATIONS.

53. Identifying Machine Switching Lines. Follow methods specified in specifications for MACHINE SWITCHING STATIONS.

54. The coin collector must be free from grounds. Test coin collector for grounds after installation is made by connecting one clip of the test set to the battery side of line and touching the metal of the coin collector with the other clip. If no click is heard the coin collector is O.K. If click is heard, ground should be located and cleared before final O.K. is received.